

**The Designer's Choice**  
Exhibition & Display system

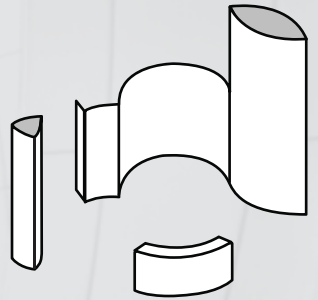

EGO is like Lego® in many ways. There are an endless number of shapes and sizes to fit individuals with different desires and technical abilities.

To make it easier for you, we have made the following division into three main “assembly levels”

LEGO® indicates trademarks of the LEGO Group

Large graphic area  
No visible framework



EGO - The NEW design language

Using a curved rod to achieve endless shapes

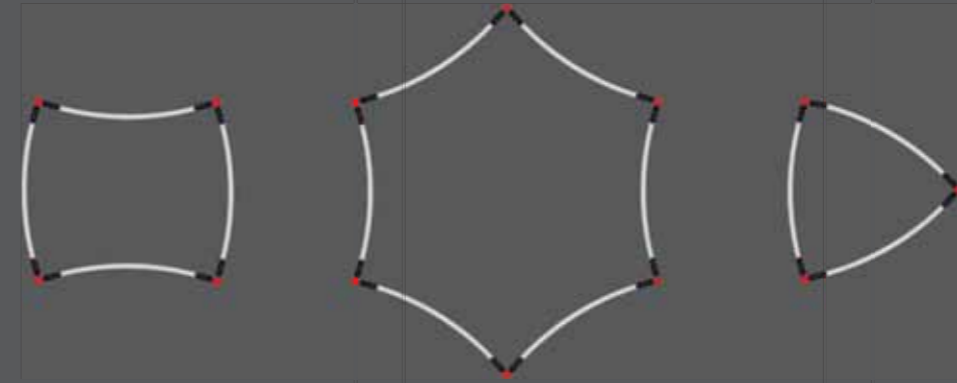

**Novice – business minded**

Using the 3 basic components (junctions, rods and wings).  
Build from assembly instructions.



**Intermediate – technically minded**

Using all standard components and add-on features of the system.  
Prior assembly/product training recommended.



**Advanced – professionally minded**

Designing and using special solutions.  
Professional trade show builder.

360 degree visibility  
Curved shapes



**Wall Unit - D1**  
3x3 m / 10x10 ft.



**Level 2**  
Intermediate



EGO is an “ambassador” for your brand. It gives a very clean message to your booth and thereby highlights your company brand in a powerful way.

No visible framework to be seen !



**Wall Unit - D19**  
4x3 m / 13x10 ft.

The unique EGO magnet-to-magnet solution, and an absolute refinement in production, secures perfect alignment between the graphic panels.

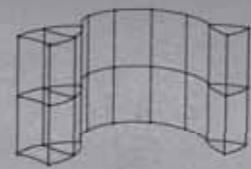
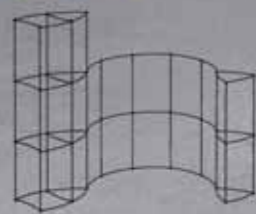
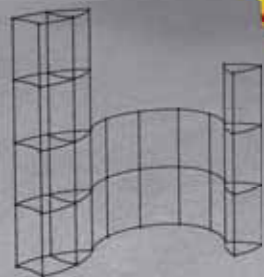

**3** Level 3  
Advanced

**2** Level 2  
Intermediate



**Wall Unit - D1**  
3x3 m / 10x10 ft.



**Level 2**  
Intermediate

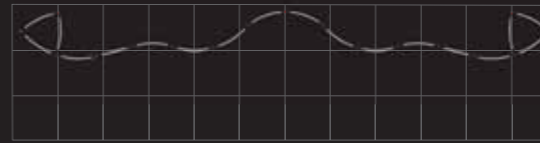

**Wall Unit - D20**  
12x3 m / 40x10 ft.



**Level 2**  
Intermediate

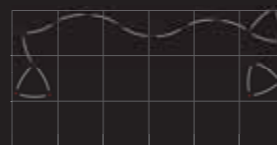

**Wall Unit - D28**  
6x3 m / 20x10 ft.



**Level 2**  
Intermediate



## Tower Units

Size and shape are the keys!

EGO has many different tower shapes to choose from.

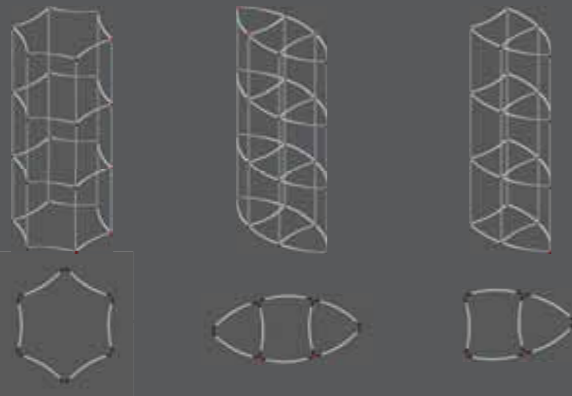

T14

T4

T2

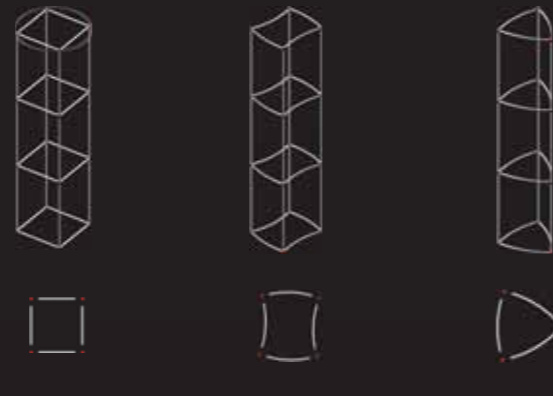

T15

T7

T1



 Level 1  
Novice

**Tower Unit - T4**  
Height: 560 cm / 18.5 ft.



 Level 1  
Novice

**Tower Unit - T1**  
Height: 340 cm / 11.25 ft.



**Tower Unit - T7**  
Height: 340 cm / 11.25 ft.

 Level 1  
Novice



EGO enables you to make a real impression at the show – to be different and to stand out from the other exhibitors.

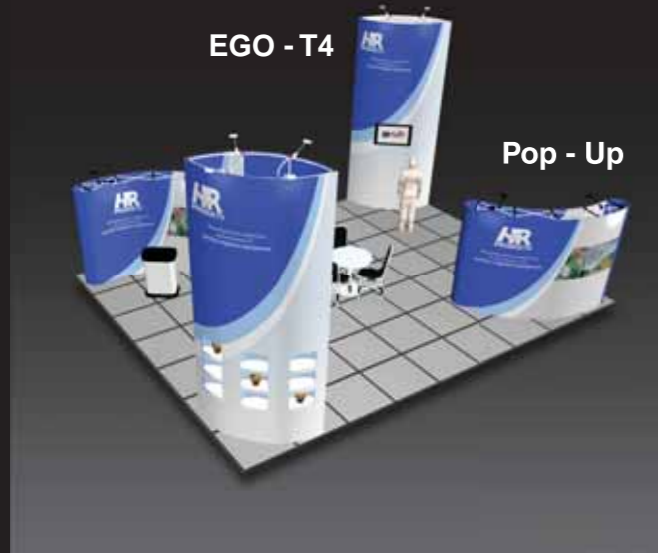

 Level 1  
Novice

**Tower Unit - T4**  
Height: 450 cm / 14.75 ft.

Examples of EGO towers, combined with Mark Bric Snap-Ups (Pop-Up).



 Level 1  
Novice

**Tower Unit - T2**  
Height: 450 cm / 14.75 ft.





Customised Reception Unit

## Turning ideas into reality



Product samples



LCD & Shelf

EGO delivers all of the capabilities to make a complete exhibition, using the same design language:

- Wall Units
- Tower Units
- Reception Units
- Ceiling Suspension Units

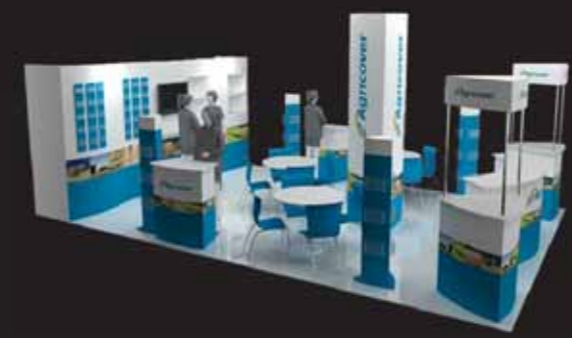

Light box - Transparent Panel





EGO brings to the market its own unique language. Much more room for creativity and customized designs, compared to the traditional and more limited stand building and pop-up systems.

 **Level 3  
Advanced**

**Wall Unit**  
6x3 m / 20x10 ft.



- The water industry's most experienced provider of membrane-based water systems
- The leader in advanced UF, NF, RO, ED, EDR and EDI technologies
- Membrane systems of any size for any treatment need
- A broad line of complementary equipment and consumables
- Comprehensive service programs and support networks
- Structured financing options



Reception units



 Level 1  
Novice

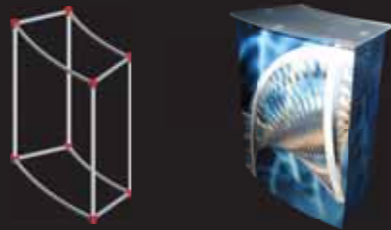

 Level 2  
Intermediate





### Features / Add-ons

The combination of function and elegance comes to its full advantage with EGO's ability to carry heavy accessory items such as LCDs, shelving, show cases etc. with room for much



Product Showcase



Ceiling Suspension Units



Shelving



Storage Panel Doors



EGO is the most distinguished graphic panel system available, with a superior visual impact and offering many unique advantages over competitive systems.

The system is ideal for larger public areas, receptions, museums, trade shows etc.

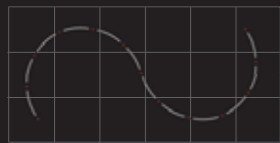

**Level 2  
Intermediate**

Double-sided panel wall for open spaces.  
Thickness of the wall is only 6 cm - unique and elegant !

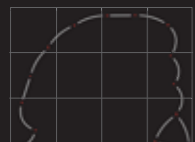

**Level 2  
Intermediate**

A standard 4x3m / 13x10 ft. trade show booth (one side open) completely covered with nicely curved EGO

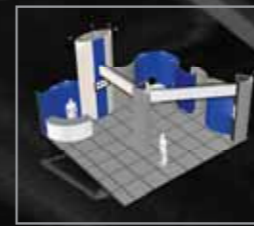

Integrate EGO with truss systems via the use of standard components.



**Level 3**  
Advanced



**Level 2**  
Intermediate



**Level 2**  
Intermediate



**Level 2**  
Intermediate



**Level 2**  
Intermediate

**EGO design illustrations**

3D illustrations are located on the website, in the 'customer design' section.

A wide variety of illustrations help spark your creativity.

EGO offers a large amount of graphic print area in relation to the exhibition floor space.



**Level 3**  
Advanced



**Level 3**  
Advanced



**Level 1**  
Novice



**Level 2**  
Intermediate



**Level 3**  
Advanced



Think green - think economical  
 EGO can be reused, reconfigured  
 and recycled !

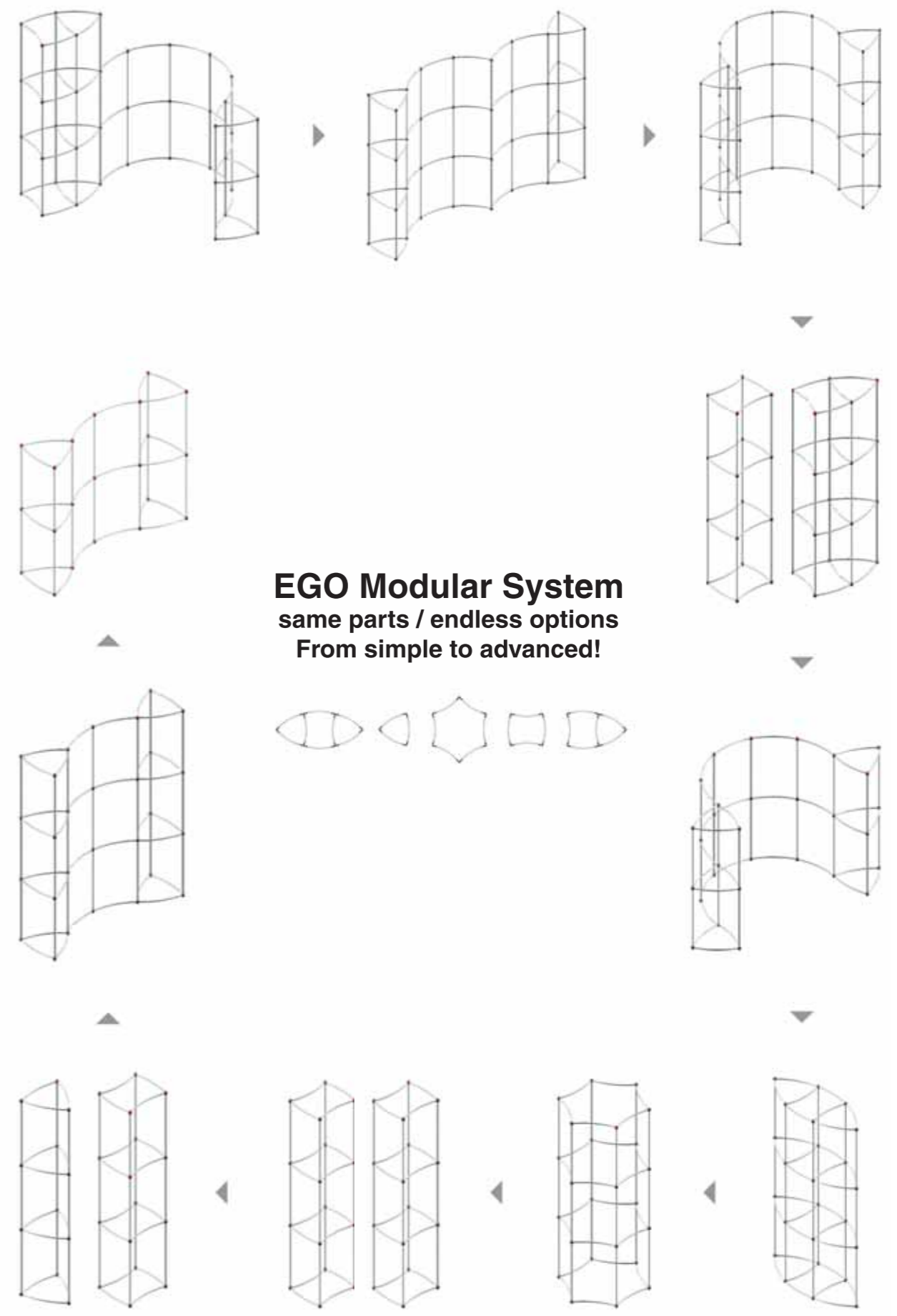

**EGO Modular System**  
 same parts / endless options  
 From simple to advanced!



## Design Support

Global Customer Service



## Website Support

For each standard EGO unit, there is a panel size PDF and parts list available for download.



Panel Area: 8.5 m<sup>2</sup>

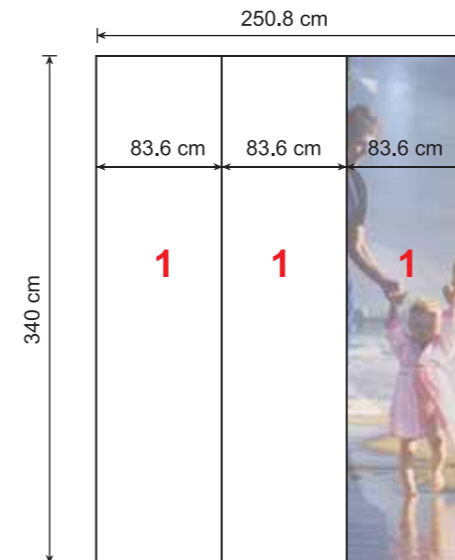

## Parts list & Panel size PDFs

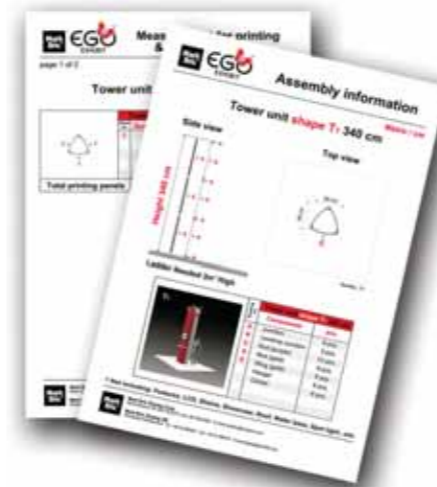

[www.markbricdisplay.com/ego](http://www.markbricdisplay.com/ego)

## Assembly videos

[www.markbricdisplay.com/ego/product-videos.html](http://www.markbricdisplay.com/ego/product-videos.html)



## Photo Gallery

Real photos of exhibitions and booths



## Customer Designs

3x3 / 3x4 / 3x6 areas, and more...





EGO provides completely tool-free assembly.



 **Level 3**  
Advanced

EGO is extremely compact during transport and storage.



### Why Choose Ego ?

A top-of-the line exhibition system  
To make a real impression  
Size and shape are the keys

No visible framework  
Large graphic area in relation to floor space  
Add-ons (LCDs, shelving etc.)

Fits all: Novice to professional  
Standard units or customized  
Trade show booths, 3x3, 3x4, 3x6 etc.  
Technical advantages + tool free assembly  
Connects to other systems, f.ex. truss

Modular system / economical  
Can be reused, reconfigured and recycled  
Room for creativity

From idea to delivery in short time  
Compact for storage and shipment  
Global support





**BANNERUP**<sup>®</sup>  
A Family of Dependable Displays



**BANNERRAIL**<sup>®</sup>  
A Family of Dependable Displays



**EGO**  
EXHIBIT



**FLEXIFRAME**<sup>®</sup>  
A Family of Dependable Displays



**Impression**<sup>™</sup>  
A Family of Dependable Displays



**Multi Master**<sup>™</sup>  
A Family of Dependable Displays



**SNAPUP**<sup>®</sup>  
A Family of Dependable Displays



**SWINGUP**<sup>™</sup>  
A Family of Dependable Displays



**Snappy Frame**<sup>™</sup>  
A Family of Dependable Displays

## OUR QUALITY - YOUR GUARANTEE

All Mark Bric products are manufactured with the highest standard of workmanship and the best quality of materials available.

All products are constantly subjected to demanding quality control, well tested on the market and designed to provide years of trouble-free use.