

Le choix du design
Système d'exposition

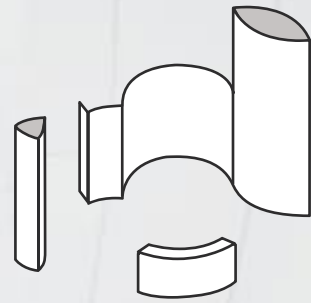

EGO est comme LEGO à bien des égards. Il existe un nombre infini de formes et de tailles pouvant convenir à tous et permettant de réaliser un ensemble technique et visuel personnalisé.

Pour vous guider, nous avons établis 3 niveaux de difficulté de montage.



EGO - Un NOUVEAU design pour vos évènements

Une simple traverse courbe pour une infinité de formes



Novice - simple

Utilisation des 3 composants de base (nœuds de jonction, montants, profilés magnétiques).
Montage rapide à partir de la notice.



Intermédiaire - technique

Utilisation de tous les composants standards et ajout d'accessoires. Une démonstration de montage est recommandée.



Avancé - professionnel

Conception et utilisation de solution spécial.
Montage par professionnel.

Une grande surface de visuel
sans structure visible

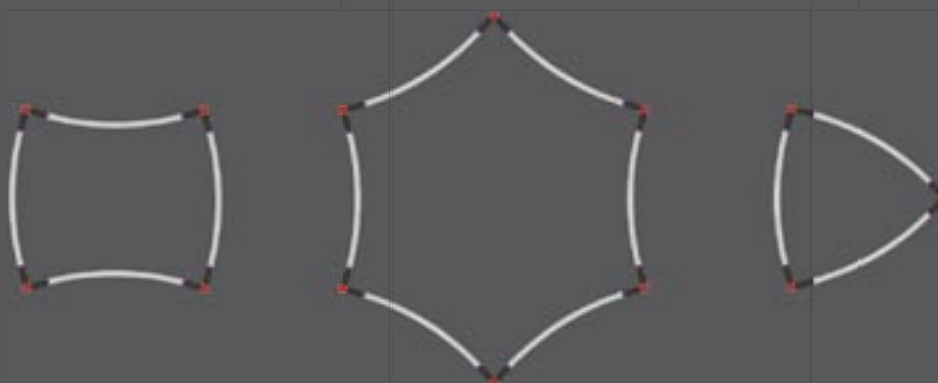

Mark
Bric®

EGGO
EXHIBIT

Visibilité sur 360 degrés
Formes Incurvées



Mur avec tours
D1 – 3x3 m



Niveau 2
Intermédiaire

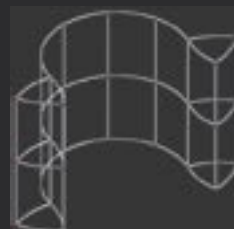



EGO est «l'ambassadeur» de votre marque. Votre stand transmet ainsi un message clair mettant en avant de manière significative votre entreprise.

Une grande surface de visuel sans structure visible!

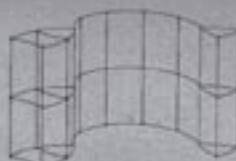
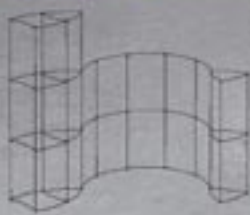

Niveau 3
Avancé



Niveau 2
Intermédiaire



Mur avec tours
D19 – 4x3 m

Le système de magnétisation pour le montage des visuels EGO, garantit un alignement parfait entre chaque visuels.







Mur avec tours
D1 – 3x3 m



Niveau 2
Intermédiaire

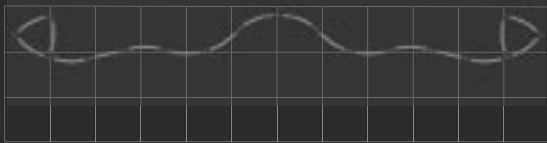

Mur avec tours
D20 – 12x3 m



Niveau 2
Intermédiaire

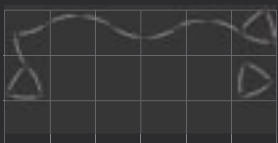

Mur avec tours
D28 – 6x3 m



Niveau 2
Intermédiaire



Tours

La diversité des formes et hauteurs de EGO en sont la clé !

Voici différentes configurations de tour EGO.

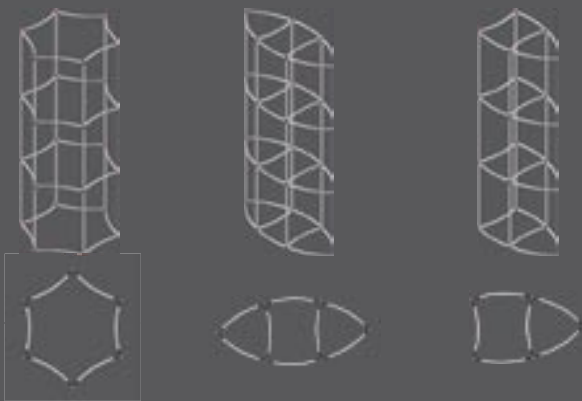

T14

T2

T4

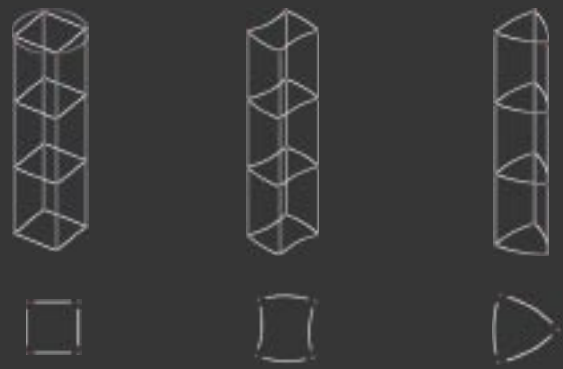

T15

T7

T1



Niveau 1
Novice

Tour – T4
Hauteur: 560 cm



Niveau 1
Novice

Tour – T1
Hauteur: 340 cm

creadhésif

AFFICHEZ VOUS

- autocollants
- bâches & panneaux
- enseignes
- véhicules
- matériel d'expo
- textiles
- briquets & stylos

www.creadhesif.ch

AFFICHEZ VOUS

- autocollants
- bâches & panneaux
- enseignes
- véhicules
- matériel d'expo
- textiles
- briquets & stylos

creadhésif

Tour – T7
Hauteur: 340 cm

 Niveau 1
Novice



EGO vous permet de faire une forte impression sur salon -
La différence vous permettra de vous démarquer des autres
exposants.



Niveau 1
Novice

Tour – T2
Hauteur: 450 cm

Exemples d'une tour EGO, combiné avec des stands parapluies
Mark Bric Display.



Niveau 1
Novice

Tour – T4
Hauteur: 450 cm



Tour EGO 450 cm

Stand parapluie 230 cm





unité d'accueil personnalisée

Transformez vos idées en réalité



Échantillons de produits



LCD & étagère

EGO offre toutes sortes de possibilités, afin de réaliser un stand complet :

- Mur
- Tour
- Comptoir
- Suspension

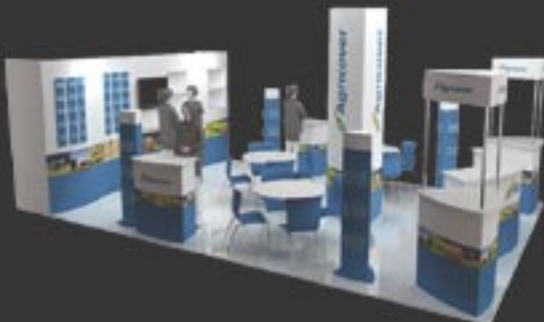

Tour rétro-éclairée – Visuel transparent



EGO apporte sur le marché son emprunte unique.

Permet une créativité plus libre, avec des modèles personnalisés, par rapport au stand traditionnel ou au stand parapluie, plus limités.

che
thology

RoACTEMRA
tocilizumab

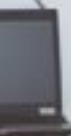

Unica terapie autorizată pe receptorul IL-6

PENTRU VIAȚA NORMALĂ

A pacienților cu poliartrită reumatoidă

RoACTEMRA

IL-6 RoACTEMRA

SUPERIORITATE - RoACTEMRA

CALITATEA VIAȚEI - RoACTEMRA

RoACTEMRA
tocilizumab

RoACTEMRA
tocilizumab



Niveau 3
Avancé

Mur avec Tours
6x3 m

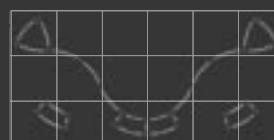

- The water industry's most experienced provider of membrane-based water systems
- The leader in advanced UF, NF, RO, ED, EDR and EDI technologies
- Membrane systems of any size for any treatment need
- A broad line of complementary equipment and consumables
- Comprehensive service programs and support networks
- Structured financing options



Comptoir



Niveau 1
Novice





Niveau 2
Intermédiaire



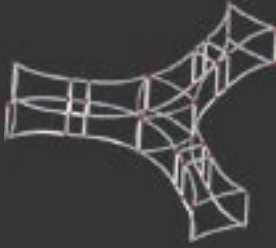

Caractéristiques / Accessoires

Tout en conservant son élégance, EGO offre de nombreux avantages, particulièrement le montage d'accessoires lourds et la multitude d'espace de rangement.



Vitrine de produits

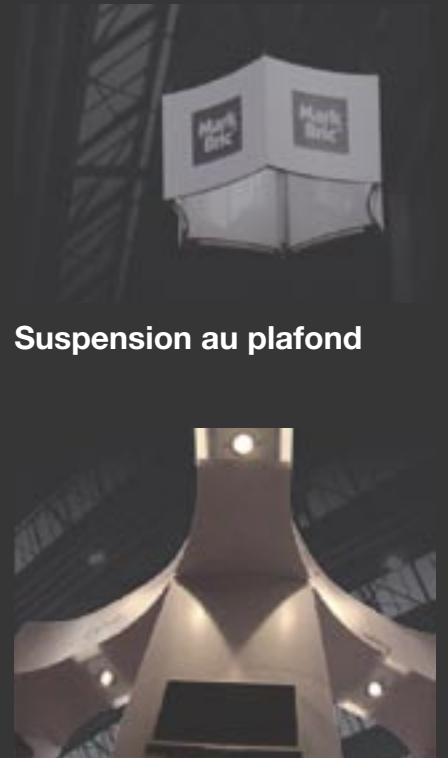

Suspension au plafond



Connexion par pont



Étagères



Portes pour rangement



EGO possède une surface de communication visuelle unique offrant de multiples avantages.

Le système EGO est idéal pour les grands espaces publics ; réceptions, musées, salons commerciaux, etc.

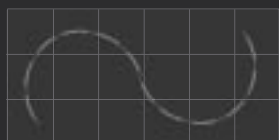

Niveau 2
Intermédiaire

Panneau mural double face pour espaces ouverts.
L'épaisseur de la paroi n'est que de 6 cm - unique et élégant !



Niveau 2
Intermédiaire

Voici un stand 4x3m (avec un côté ouvert) pour vos salons, entièrement réalisé grâce aux traverses courbes EGO.



Water & Process Technologies



ZeeWeed MBR
for municipal and
industrial water



- Produces a high quality effluent that can be safely discharged or reused for irrigation, industrial processes or groundwater recharge
- Rugged fiber ensures longer membrane life
- Compact design yields smaller plant footprints minimizing capital costs
- Ideal for retrofits of existing infrastructure
- Full line of packaged Z-MBR systems for flows under 1 MGD
- Proven system performance provides peace of mind



Water & Process Technologies

ete sol
er



your bus

Around the world, GE power & water and chemicals are proven in countries

Reverse

Hollow

EDR

M

Les poutres sont intégrées à EGO via l'utilisation de composants standard.



 **Niveau 3**
Avancé



 **Niveau 2**
Intermédiaire



 **Niveau 2**
Intermédiaire

illustrations design EGO

Retrouver toutes les illustrations en 3D sur le site, dans la partie «customer design».

Une grande variété d'illustrations sont disponibles afin de stimuler votre créativité.

EGO vous offre une large surface imprimée en rapport avec votre espace au sol.



 **Niveau 3**
Avancé



 **Niveau 1**
Novice



Niveau 2
Intermédiaire



Niveau 2
Intermédiaire



Niveau 3
Avancé



Niveau 2
Intermédiaire



Niveau 3
Avancé



Pensez vert - pensez économique.
EGO peut être réutilisé,
reconfiguré et recyclé.



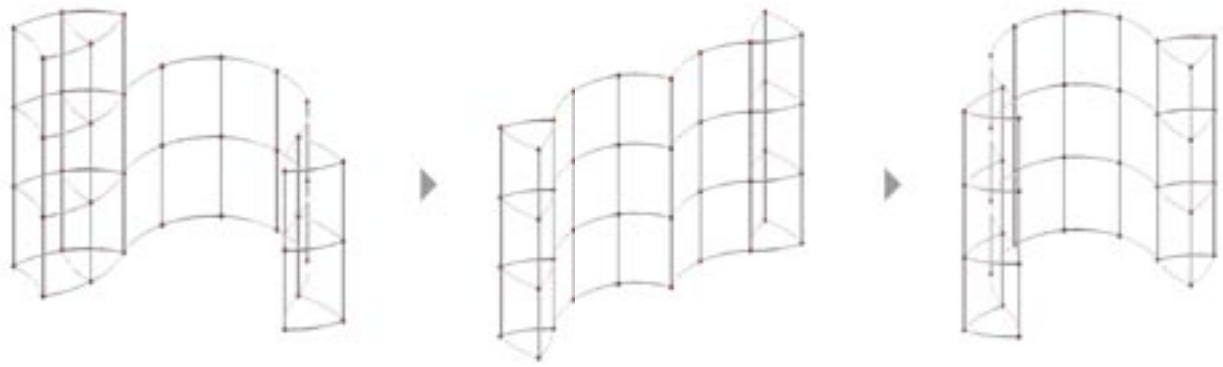

Système modulaire EGO
mêmes composants / infinités d'options.
Du plus simple au plus avancé!

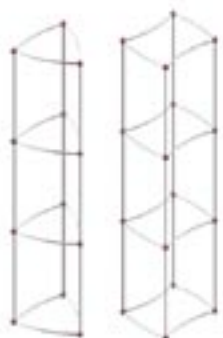
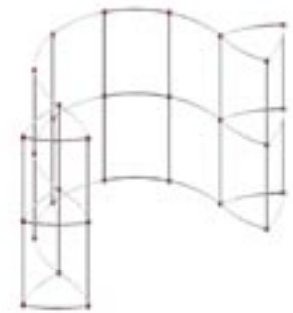
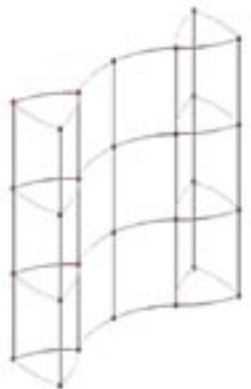

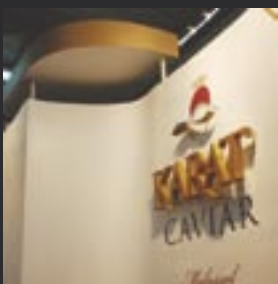

Voici un stand EGO avec dessus de tour style "couronne" et écran LCD.

Le logo d'entreprise peut être adapté sur le mur en 3D

Le comptoir a un plateau semi-transparent rétro-éclairé





Mur avec tours
7x4 m



Niveau 2
Intermédiaire

Site de support
www.markbricdisplay.com/ego

Galerie de photo



Vidéo d'assemblage





Réalisations des clients



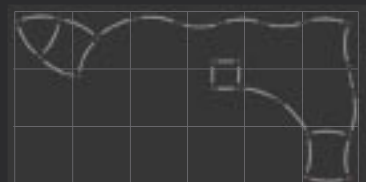

L'assemblage de EGO se réalise sans outil.



 **Niveau 3**
Avancé

EGO est extrêmement compact en terme de transport et de stockage.



Pourquoi choisir ego?

- Le « top » du système d'exposition
- Pour faire une véritable impression
- La taille et la forme sont les clés du stand

- Aucune structure visible
- Grande surface imprimée en rapport avec votre espace au sol.
en rapport à la surface d'exposition
- Accessoires (LCD, étagères etc.)

- Convient à tous: débutants à professionnels
- Les unités sont standards ou sur mesure
- Stands pour salons professionnels, 3x3, 3x4, 3x6 etc
- Techniques de montage avantageuse sans outil
- Se connecte à d'autres systèmes, ex. poutre

- Système modulaire / économique
- Peut être réutilisé, reconfiguré et recyclé
- Laisse place à la créativité

- Possibilité de livraison dans un délai court
- Compact pour le stockage et l'expédition
- Support global disponible



NOTRE QUALITE : VOTRE GARANTIE

Les produits Mark Bric sont fabriqués à partir des meilleurs matériaux disponibles sur le marché.

Tous les produits subissent régulièrement des contrôles qualités, ils sont testés afin de vous garantir une grande durée de vie.